

# GRUA TORRE TOWER CRANE

# J47NS

De acuerdo con UNE 58-101-92 / According to FEM 1001-87  
 Directivas de nivel de potencia acústica / Sound power level directives 84/534/CEE & 87/405/CEE  
 Directivas de máquinas / Machinery directives 89/392/CEE & 91/368/CEE

SISTEMA DE CALIDAD CERTIFICADO SEGUN  
 QUALITY ASSURANCE SYSTEM CERTIFIED ACCORDING TO  
**UNE-EN-ISO 9001** **CE**

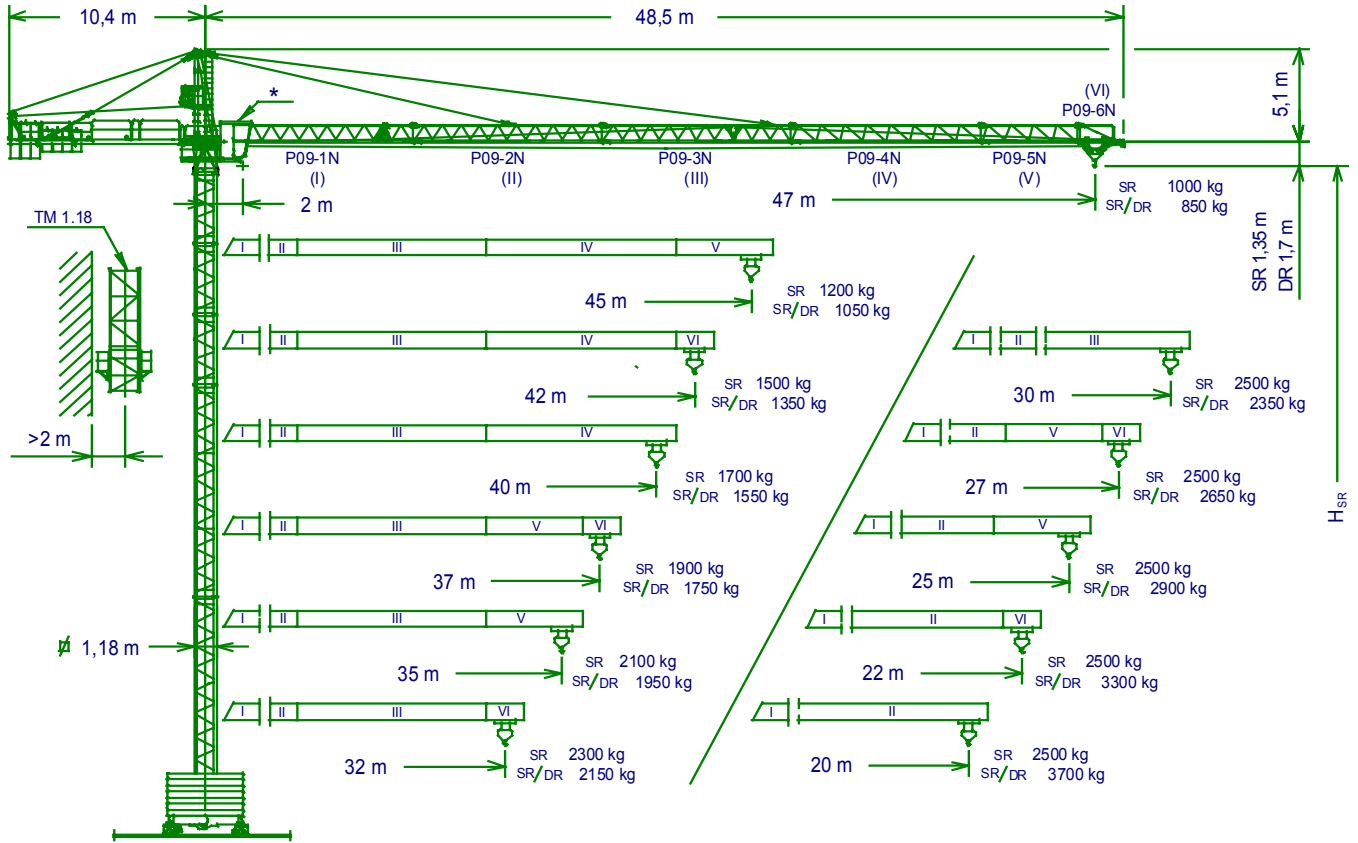

\* optional  
 optional

$H_{DR} = H_{SR} - 0,35$   
 $H_{SR} =$  Altura máxima bajo gancho sin arristrar ( m )  
 Maximum height under hook without fastening  
 Sin cabina / Without cabin = **sc**  
 Con cabina / With cabin = **cc**

P09-1N	149.40.000	BTX 45 / BEX 45	137.20.500
P09-2N	149.41.000	BTX 38R / BEX 38R	137.20.000
P09-3N	149.42.000	BTX 38 / BEX 38	146.20.000
P09-4N	149.43.000	AR 12	137.21.000
P09-5N	149.44.000	AN 12	146.21.000
P09-6N	149.45.000	BE 442	146.24.000
TR 8R	137.30.000	TM 1.18	137.35.000
TN 2	146.32.500		

TR 8      TR 8R  
 TN 4      TN 2

(H<sub>SR</sub>) ESTACIONARIA / STATIONARY

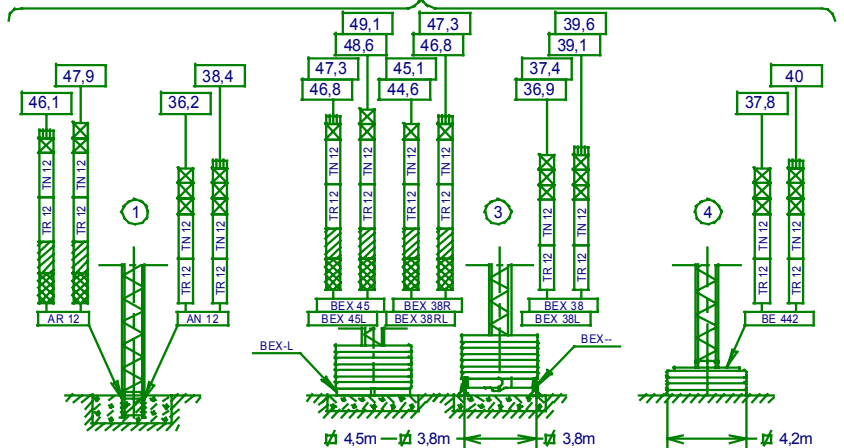
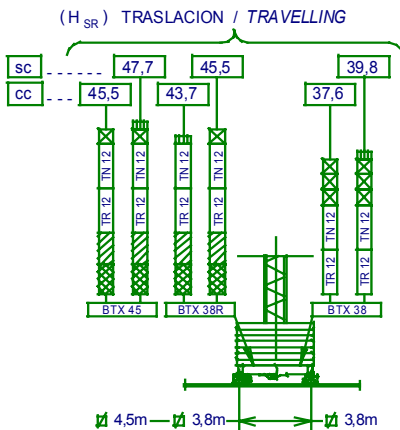

**JASO EQUIPOS DE OBRAS Y CONSTRUCCIONES, S.L.**

Fecha / Date: 11-02-03 - Reservado el derecho a modificaciones sin previo aviso / Subject to modification, without previous warning







SR (kg)	Cargas máximas / Maximum loads												2000-2500 a
	Alcance del gancho (m)						Hook reach (m)						
PLUMA / JIB	47	45	42	40	37	35	32	30	27	25	22	20	
47 m	1000	1055	1145	1215	1330	1420	1570	1700	1905	2000-2075	2000-2385	2000-2500	25,83-21,08 m
45 m	—	1200	1300	1375	1505	1600	1775	1900	2000-2145	2000-2325	2000-2500	2000-2500	28,78-23,49 m
42 m	—	—	1500	1600	1730	1850	2000-2040	2000-2200	2000-2455	2000-2500	2000-2500	2000-2500	32,54-26,56 m
40 m	—	—	—	1700	1855	1975	2000-2180	2000-2340	2000-2500	2000-2500	2000-2500	2000-2500	34,59-28,23 m
37 m	—	—	—	—	1900	2000-2025	2000-2230	2000-2395	2000-2500	2000-2500	2000-2500	2000-2500	35,33-28,83 m
35 m	—	—	—	—	—	2000-2100	2000-2320	2000-2485	2000-2500	2000-2500	2000-2500	2000-2500	35-29,85 m
32 m	—	—	—	—	—	—	2000-2300	2000-2470	2000-2500	2000-2500	2000-2500	2000-2500	32-29,64 m
30 m	—	—	—	—	—	—	—	2000-2500	2000-2500	2000-2500	2000-2500	2000-2500	30 m
27 m	—	—	—	—	—	—	—	—	2000-2500	2000-2500	2000-2500	2000-2500	27 m
25 m	—	—	—	—	—	—	—	—	—	2000-2500	2000-2500	2000-2500	25 m
22 m	—	—	—	—	—	—	—	—	—	—	2000-2500	2000-2500	22 m
20 m	—	—	—	—	—	—	—	—	—	—	—	2000-2500	20 m



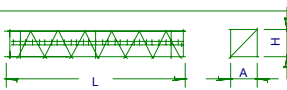
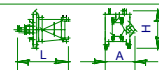
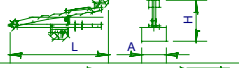

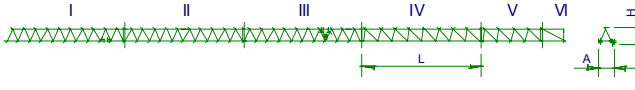
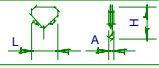
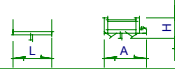

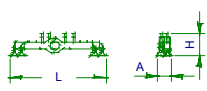
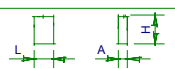
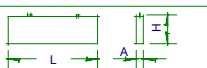
SR / DR (kg)	Cargas máximas / Maximum loads												2000 - 2500 4000 - 5000 a			
	Alcance del gancho (m)						Hook reach (m)									
PLUMA / JIB	47	45	42	40	37	35	32	30	27	25	22	20	15			
47 m	850	905	995	1065	1180	1270	1420	1540	1755	1925	2000-2235	2000-2500 2500	2000-2500 3450	24,19 13,12	19,98 10,67	
45 m	—	1050	1150	1225	1355	1460	1625	1760	1995	2000-2200	2000-2500 2535	2000-2500 2825	2000-2500 3900	26,96 14,62	22,26 11,9	
42 m	—	—	1350	1450	1580	1700	1885	2000-2050	2000-2305	2000-2500 2525	2000-2500 2915	2000-2500 3250	2000-2500 4000	2500 4450	30,48 16,53	25,17 13,45
40 m	—	—	—	1550	1705	1825	2000-2030	2000-2190	2000-2475	2000-2500 2700	2000-2500 3120	2000-2500 3470	2000-2500 4000	2500 4750	32,4 17,57	26,76 14,3
37 m	—	—	—	—	1750	1870	2000-2080	2000-2245	2000-2500 2535	2000-2500 2770	2000-2500 3195	2000-2500 3550	2000-2500 4000	2500 4860	33,09 17,95	27,33 14,6
35 m	—	—	—	—	—	1950	2000-2165	2000-2340	2000-2500 2635	2000-2500 2880	2000-2500 3320	2000-2500 3690	2000-2500 4000	2500 5000	34,26 18,58	28,29 15,12
32 m	—	—	—	—	—	—	2000-2150	2000-2320	2000-2500 2615	2000-2500 2855	2000-2500 3295	2000-2500 3660	2000-2500 4000	2500 5000	32 18,45	28,09 15,02
30 m	—	—	—	—	—	—	—	2000-2350	2000-2500 2650	2000-2500 2895	2000-2500 3340	2000-2500 3710	2000-2500 4000	2500 5000	30 18,67	28,43 15,19
27 m	—	—	—	—	—	—	—	—	2000-2500 2650	2000-2500 2900	2000-2500 3335	2000-2500 3700	2000-2500 4000	2500 5000	27 18,66	27 15,18
25 m	—	—	—	—	—	—	—	—	—	2000-2500 2900	2000-2500 3345	2000-2500 3720	2000-2500 4000	2500 5000	25 18,7	25 15,22
22 m	—	—	—	—	—	—	—	—	—	—	2000-2500 3300	2000-2500 3670	2000-2500 4000	2500 5000	22 18,47	22 15,03
20 m	—	—	—	—	—	—	—	—	—	—	—	2000-2500 3700	2000-2500 4000	2500 5000	20 18,62	20 15,15

CONTRAPESOS / COUNTERWEIGHTS						2360 kg	1500 kg	Montaje pluma / Jib fitting-up					
PLUMA / JIB	47	45	42	40	37	35	32	30	27	25	22	20	
SR													
SR / DR													
Total (kg)	13080	13080	13080	11580	11580	10720	10720	10080	8580	7720 8580	6220 7720	5360 7080	

LASTRES INFERIORES / LOWER BALLASTS		Para alturas intermedias tomar el lastre correspondiente a la altura superior For intermediate heights take the ballast corresponding to the higher height					
Altura bajo gancho (m) / Height under hook (m)		49	46	40	30	22	18
Numero de piedras a colocar Number of ballast blocks to put	BEX 45 / BTX 45	14	12	10	8	6	
	BEX 45L	14	12	10	8	6	
	BEX 38R / BTX 38R BEX 38 / BTX 38	—	14	12	10	8	6
	BEX 38RL / BEX 38L	—	14	12	10	8	6



DENOMINACION DENOMINATION		L (m)	A (m)	H (m)	Peso (kg) Weight (kg)		
Torre Tower section		TR 8R - TR8	8,07	1,19	1,19	2575-2515	
		TR 12 - TN 12	12,01	1,19	1,19	2840-2780	
		TN 4RA - TN 4	4,06-4,09	1,19	1,19	1100-1055	
		TN 2	2,29	1,19	1,19	785	
Torre asiento de pista+Base punta torre+Orientación. Slewing table+Tower head base+Slewing mechanism		2,94	1,65	2,15	2100		
Estructura punta de torre+elevación Tower head structure+hoisting		5,46	1,19	2,31	1990		
Torre asiento pista+punta torre+orientación+elevación Slewing table+Tower head+slewing+hoisting		6,97	1,65	2,42	4090		
Tramo de pluma Jib section		P09-1N(I)	10,13	1,00	1,13	1020	
		P09-2N(II)	10,16	0,87	1,14	940	
		P09-3N(III)	10,15	0,87	1,12	880	
		P09-4N(IV)	10,15	0,87	1,03	575	
		P09-5N(V)	5,26	0,87	1,02	295	
		P09-6N(VI)	2,13	0,86	1,02	110	
Polipasto Hook assembly		SR	0,76	0,16	0,96	135	
		DR	0,76	0,20	1,40	170	
Carro Crab		SR	0,10	1,33	0,73	110	
		DR	1,04	1,37	0,88	175	
Contrapluma con plataformas Counterjib with platforms		9,45	1,41	0,43	1460		
Plataforma y cabina Platform and cabin		3,69	1,63	2,25	820		
Base grúa Crane base		Estacionaria III / Stationary III	BEX 38	6,38	0,84	1,53	3400
			BEX 38R	6,38	0,84	1,47	3800
			BEX 45	7,37	0,84	1,47	4380
		Traslación / Travelling	BTX 38	6,02	1,62	1,63	4760
			BTX 38R	6,02	1,73	1,73	5230
			BTX 45	7,01	1,62	1,73	5995
Contrapeso Counterweight		Grande / Big	1,08	0,50	2,02	2360	
		Pequeño / small	1,08	0,50	1,30	1500	
Lastre Ballast		Est. III - Stationary III / Trasl. - Travelling	4,00	0,34	1,30	4100	
		Est. IV / Stationary IV	2,09	0,34	2,10	3450	
Torre de montaje Jacking cage		7,14	1,76	1,71	3105		

CARACTERISTICAS DE MECANISMOS / MECHANISMS FEATURES					Para  480V Potencias y velocidades: 20% más. 60Hz Powers and speeds: 20% more					
MECANISMOS MECHANISMS	*opcional *optional									
	EJ 2580A (A)	EJ 2566 (B)	*EJ 2566 VF (C)	*EJ 33100 VF (D)	TGM 825 TGM 825 VF	TGM 825 LVF	OR 708 VF	TCM 360 VFB		
kW		18,4			24,2		2x3	2x3	5,5	1,8
VELOCIDADES SPEEDS	SR1/DR (A) 1100 kg 2000 kg 2200 kg 4000 kg	82/41/10 m/min 41/10 m/min 41/20,5/5 m/min 20,5/5 m/min	SR2 (C) 1300 kg 0...64 m/min 2500 kg 0...32 m/min	SR2 (D) 1300 kg 0...76 m/min 2500 kg 0...51 m/min	0...25 m/min	0...25 m/min	0...0,2 0,2...0,4	0...15 15...30		
	SR2/DR (B) 1300 kg 2500 kg 2600 kg 5000 kg	64/32/8 m/min 32/8 m/min 32/16/4 m/min 16/4 m/min	DR (C) 2600 kg 0...32 m/min 5000 kg 0...16 m/min	DR (D) 2600 kg 0...38 m/min 5000 kg 0...25,5 m/min			0,4...0,8 r/min	30...60 m/min		
Max. recorrido gancho Maximum hook course	SR 144 m en 3 capas 196 m en 4 capas máx. 72 m en 3 capas DR 98 m en 4 capas máx.				 400V 50Hz	Potencia necesaria Required power	31,7 kW *37,5 kW			
Importante: A medida que la altura bajo gancho de la grúa aumenta, disminuirá la capacidad de carga. Consultar el capítulo de capacidad de carga (04.015.00) del apartado del mecanismo de elevación del fabricante. Important: When the height under hook increases, the hoisting load will decrease. Consult the chapter of load capacity (04.015.00) of the hoisting mechanism of the manufacturer's handbook.										



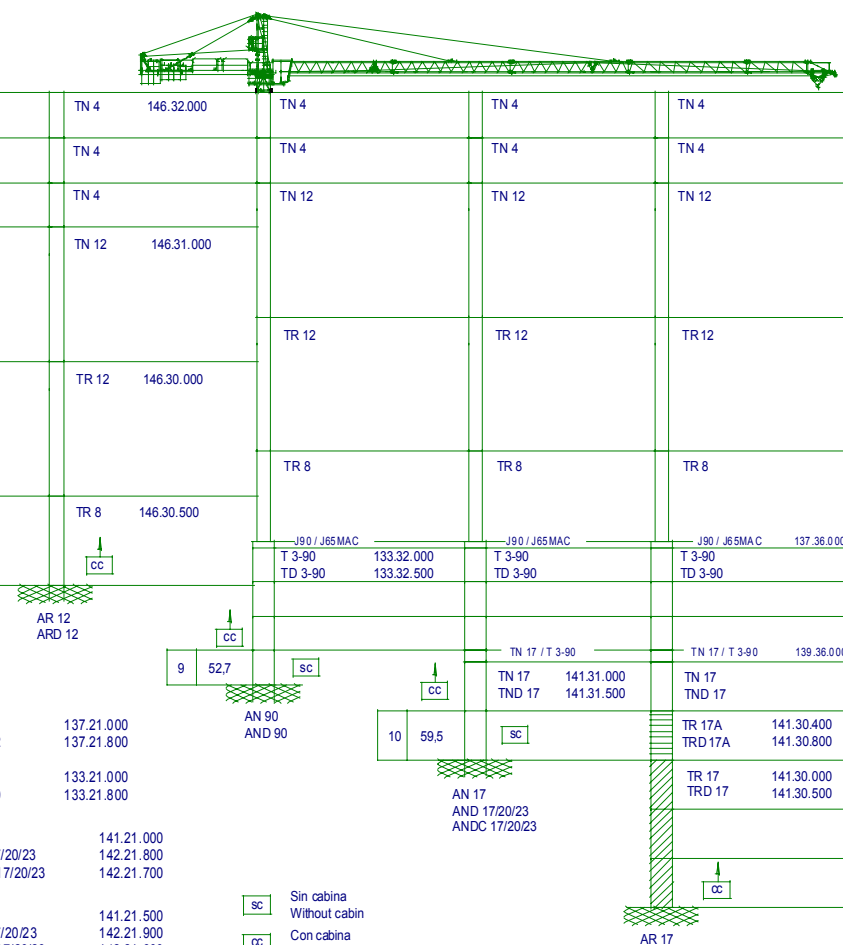

TORRES / TOWERS	ALTURA HEIGHT (m)	Componentes				ALTURA HEIGHT (m)	TORRES / TOWERS
1	4,5	TN 4	146.32.000	TN 4	TN 4	4,5	1
2	8,4	TN 4		TN 4	TN 4	8,4	2
3	12,4	TN 4		TN 12	TN 12		
4	24,3	TN 12	146.31.000			20,3	3
5	36,2	TR 12	146.30.000	TR 12	TR 12	32,2	4
6	44	TR 8	146.30.500	TR 8	TR 8	40,1	5
		J90 / J65MAC		J90 / J65MAC	J90 / J65MAC	137.36.000	
		T 3-90	133.32.000	T 3-90	T 3-90		43,7
		TD 3-90	133.32.500	TD 3-90	TD 3-90		46,7
		AR 12	137.21.000	ARD 12	ARD 12		49,7
		AN 90	133.21.000	AND 90	AND 90		52,7
		AN 17	141.21.000	AND 17/20/23	AND 17/20/23		55,2
		AN 17	141.21.500	ARD 17/20/23	ARD 17/20/23		59,6
		AN 17	142.21.000	AND 17/20/23	AND 17/20/23		63,9
		AN 17	142.21.700	AND 17/20/23	AND 17/20/23		68,3
		AR 17	141.21.500	ARD 17/20/23	ARD 17/20/23		72,6
		AR 17	142.21.900	ARD 17/20/23	ARD 17/20/23		
		AR 17	142.21.600	ARD 17/20/23	ARD 17/20/23		

sc Sin cabina / Without cabin  
cc Con cabina / With cabin

Para otras configuraciones de torre, consultar con nuestro Dpto. Técnico.  
 For other tower configurations, consult our Technical Dpt.

Transporte grúa de 37,6 m bajo gancho con traslación y sin lastre.

37,6 m under hook crane transport with travelling base and without base ballast.

En camiones / In trucks

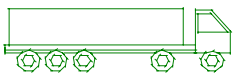

2 unidades / 2 units

En contenedores / In containers

HIGH CUBE

2 unidades / 2 units

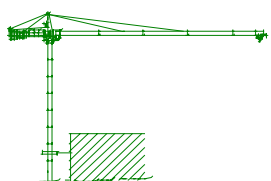

Máximo número de torres TN 4 a colocar por encima del último arriostamiento: 6

Maximum TN 4 mast sections above the last tie-back: 6

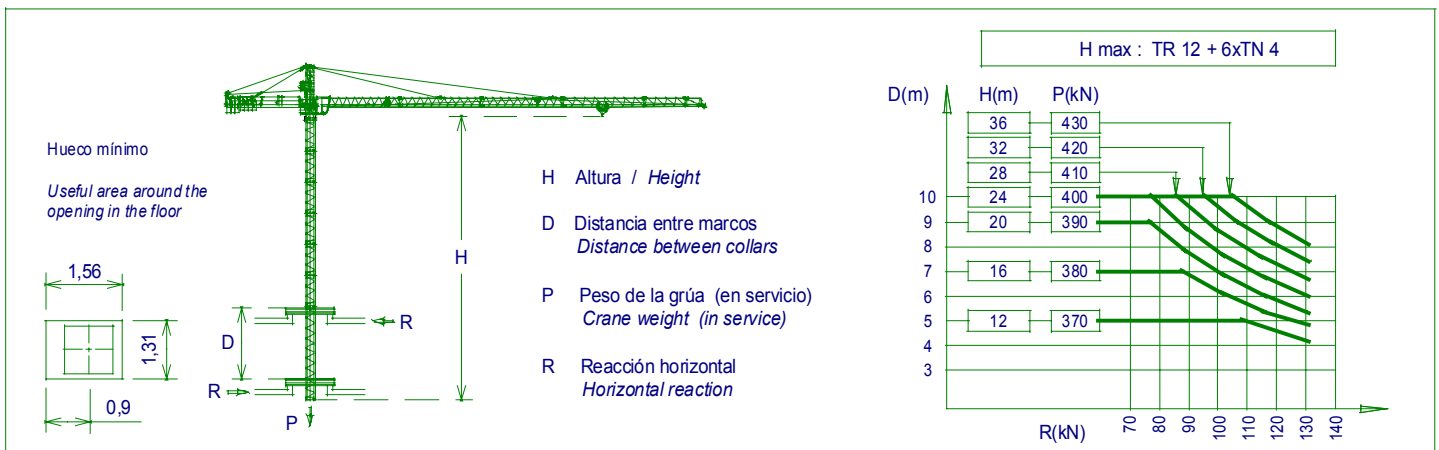

JASO EQUIPOS DE OBRAS Y CONSTRUCCIONES, S.L

Ctra./Rd. Madrid - Irún Km. 415  
 20.213 IDIAZABAL (Gipuzkoa)  
 ESPAÑA / SPAIN  
 P.O. Box, 23 - 20.200 BEASAIN

Tel. +34 943 - 18 70 00  
 Fax. +34 943 - 18 70 20  
 E-mail: jaso@jaso.com  
 http://www.jaso.com

DELEGACION / DELEGATION

Fecha / Date: 11-02-03

Reservado el derecho a modificaciones sin previo aviso / Subject to modification, without previous warning